



**ARSOPI  
THERMAL**

**Plate Heat  
Exchangers  
Chemical**



# WE ARE ARSOPI THERMAL

A Thermal Solution Expert of Plate Heat Exchangers  
“Creative and friendly. Always.”

Arsopi Thermal has become a pioneering thermal solution expert of Plate Heat Exchangers (PHE) since 1992 for its vast experience, top manufacturing quality and outstanding performance. As a member of the world class equipment provider ARSOPI Group and a technical licensee of HISAKA, one of the world’s leading PHE Japanese manufacturers, drive innovation by absorbing extensive knowledge and blending it with our cutting-edge technology and range of specialized experience.



Accessibility to our customers and ensuring their satisfaction at every stage is our priority.

We aim to facilitate desired outcomes for our clients by tailoring our services to their needs. We have extensive knowledge of PHE applications. Our wide range of plate types, corrugations, connection sizes and materials enable us to provide our customers with premium counsel in compliance with regulations so that their production plants overcome challenges and prosper.



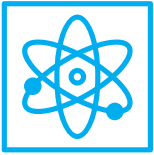

# Chemical Applications



Basic Chemicals



Agrochemicals & Fertilizers



Petrochemicals



Polymers & Plastics



Pharmaceuticals Fine Chemicals

Chemicals are an essential part of our living. Almost everything is related to chemistry. Most chemical plants work under continuous processes where the need for a reliable heat exchanger is paramount.

Arsopi Thermal manufactures strong and efficient heat exchangers prepared to withstand the chemical processes safely and to maximum effectiveness. Our expertise lets us handle a wide range of plate and gasket materials for demanding applications.

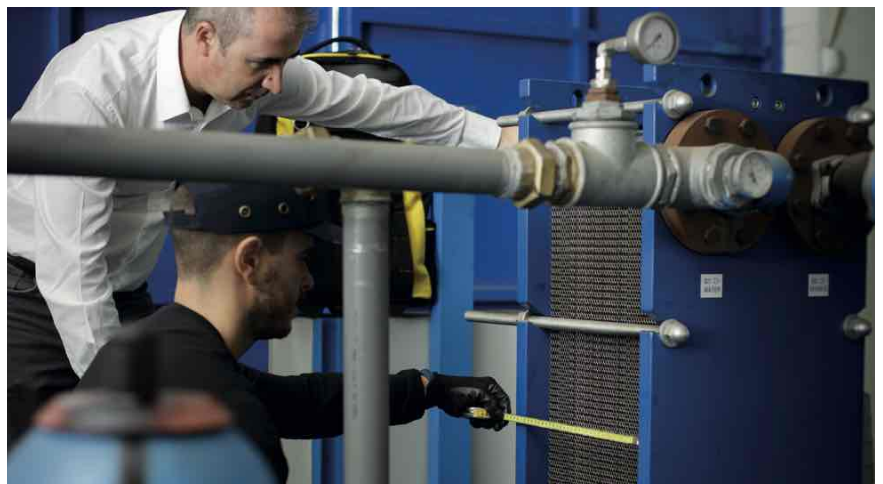

# Our Plate Heat Exchangers

Understanding complex industrial processes is key to combining excellent craftsmanship with world-class, innovative plate design, the best materials available and human experience and creativity. Our durable plate heat exchangers maintain their integrity in the toughest conditions at the most advanced chemical plants, all while going unnoticed. That is the most we can aspire for.

Performance and purpose, always.

## High Thermal Efficiency

The press-formed patterns provide a high heat transfer coefficient by a turbulence flow.

## Quick Start-up

Smaller holding volume makes quick start-up of the process. Limited fluid capacity per unit allows quick operation start up, and also possible to correspond to changes in operating conditions with high precision.

## Easy maintenance

Simple assembly and disassembly for inspection and maintenance by loosening the bolts and nuts.

## Modular Construction and Design Flexibility

Flexibility to easily implement various thermal programs and future expansion or modification.

## Lightweight and Smaller Footprint

Less weight and compact size can be realised by the thin heat transfer plates and the small holding volume. These features provide simple installation work at a low cost.

- Compressed thin heat transferring plates
- Limited fluid capacity
- Smaller heat transferring surface area

## Prevention of Liquid Inter-mixing

Gasket grooves protect it from direct contact with the liquid. The double-seal gasket with drain avoids any mixing of the two liquids preventing performance deterioration in case of a gasket failure.

## World Class of Plate Design technology

Arsopi Thermal + Hisaka

The forefront of plate design technology for special or difficult applications, expanding the use of regular plate and gasket heat exchangers.

# Technical Specifications

## FH - Industrial Application

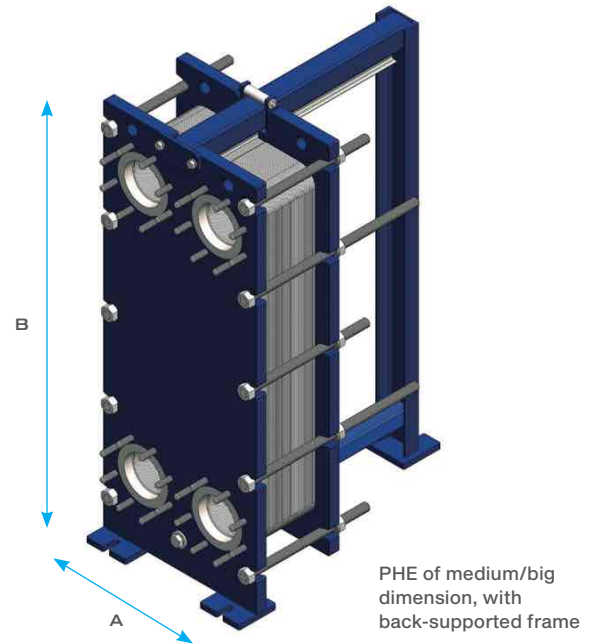
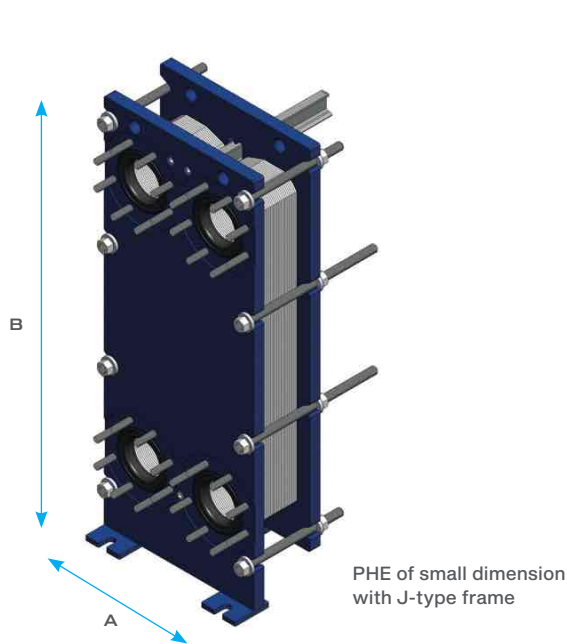

Model	Connection Diameter	Dimensions	
		A	B
FH-UX00	25	160	330
FH-UX01	50	300	835
FH-UX10	65	400	1164
FH-UX30	100	578	1786
FH-UX90	350	1300	2940
FH-UX100	500	1570	3650
FH-UX100R	500	1570	3650
FH-UX130	500	1570	4215
FH-UX110	500	1570	3650
FH-UX130R	500	1570	4215
<hr/>			
FH-LX00	50	350	860
FH-LX10	100	440	1102
FH-LX30	150	620	1546
FH-LX50	200	790	2036
FH-LX90D	400	1480	2418
<hr/>			
FH-WX10	100	515	1182
FH-WX50	200	800	2221
FH-WX90	350	1450	2829

Model	Connection Diameter	Dimensions	
		A	B
FH-SX10	65	360	1590
FH-SX20	100	540	1843
FH-SX30S	150	684	2110
FH-SX30	150	640	2673
FH-SX40	200	805	2156
FH-SX70	250	1070	2692
FH-SX80S	350	1250	2829
FH-SX80M	350	1250	2829
FH-SX80L	350	1250	3540
<hr/>			
FH-RX00	32	220	445
FH-RX10	100	460	1212
FH-RX30	150	630	1815
FH-RX50	200	800	2120
FH-RX70	250	900	2440
FH-RX90	400	1370	2990
<hr/>			
FH-GX	100	570	1835
FH-YX	350/150	970	1835





# Special Plates

## Semi-Welded Plate (FH-WX)

High-efficiency heat transfer plate suitable for heat exchange that requires high heat resistance and pressure resistance

A cassette is formed by two plates laser welded together with O-ring at portholes and a regular gasket on the outside. One fluid (aggressive media or refrigerant) is flowing through the inside of the welded cassettes and the other fluid is flowing on the outside of the cassettes (standard gasketed side).

- Fit for aggressive media that corrode synthetic rubber
- Compact, flexible and inspectable/cleanable mechanically (gasketed side)
- Welded cassettes with possibility to use excellent chemical resistance gaskets such as PTFE gasket (TCG)
- Capable to handle high pressure and high temperature fluids (up to 180°C and 4 MpaG)

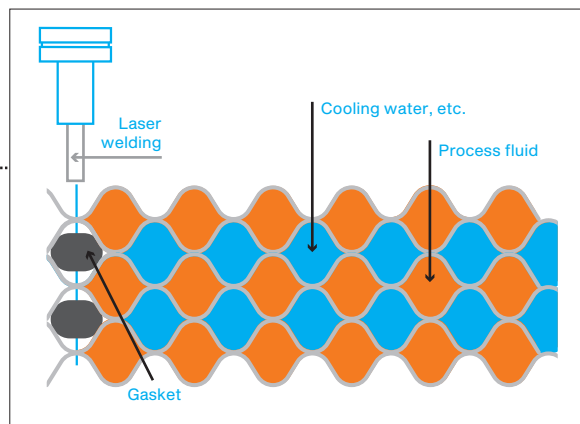
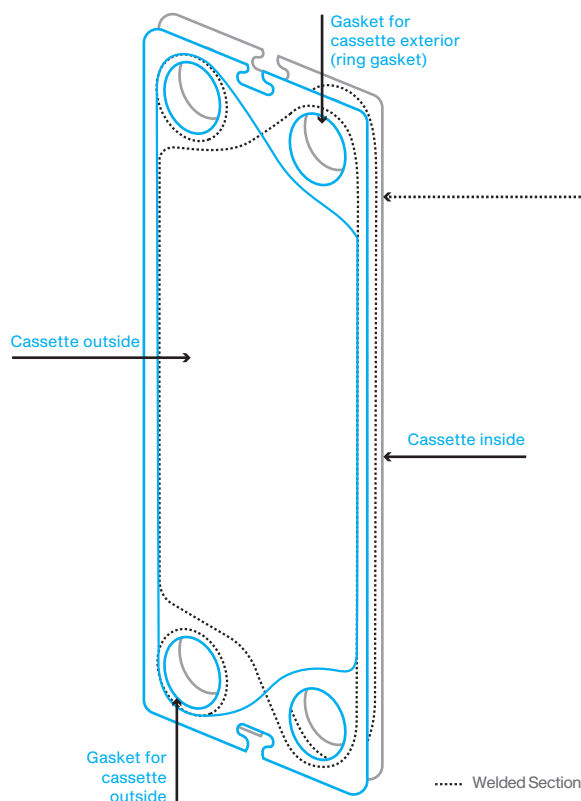

## Applications

- Heating / cooling of fluids that corrode synthetic rubber
- Heating / cooling of dangerous fluids such as sulphuric acid
- Heating / cooling for the duty exceeding the heat or pressure resistance of gasket-type plate heat exchangers
- Heating / cooling in refrigeration cycles using refrigerant

## Condenser / Gas Cooler Plate (FH-YX)

FH-YX series is specially designed for condensing and gas cooling applications, developed for heat exchanger duties of large volume of gas in vacuum systems or under low pressure

- Heat transfer performance: can be “Double” of Shell & Tube heat exchangers
- Less maintenance works, easily cleaned, and inspected
- Low cooling water consumption
- Adaptable for wide range of applications, compatible with PTFE (TCG) gaskets
- Available for various International Pressure Vessels Code & Standard

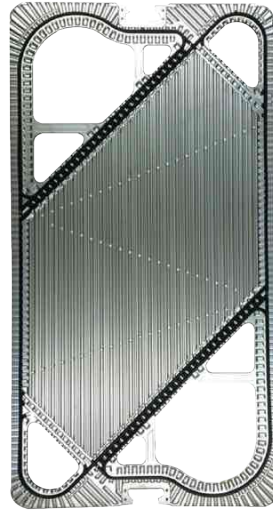

Cooling water side

YX-83 plate

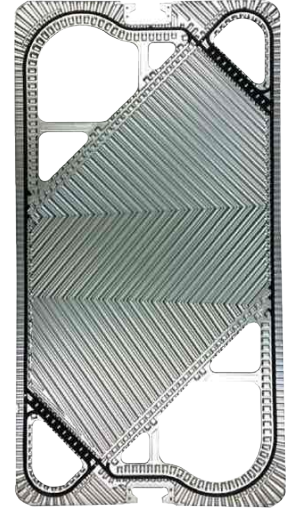

Vapor side

## Applications

- Overhead condensers for various distillation columns
- Condensers / preheaters for evaporators
- Condensers for gas drying / air conditioning
- Heat recovery exchangers from exhaust steam
- Gas coolers, etc.



# Multi Gap Plate (FH-GX)

Specially made for liquids (sludge) or high viscosity fluids containing fibers and solids

- By combination of one plate arrangement gives 3 multiple-channel configurations
- Widest channel spacing (20 mm)
- Shorter maintenance time due to the glueless system gasket (Slit-In)
- Corrosion resistant materials such as titanium can be used
- Economic design

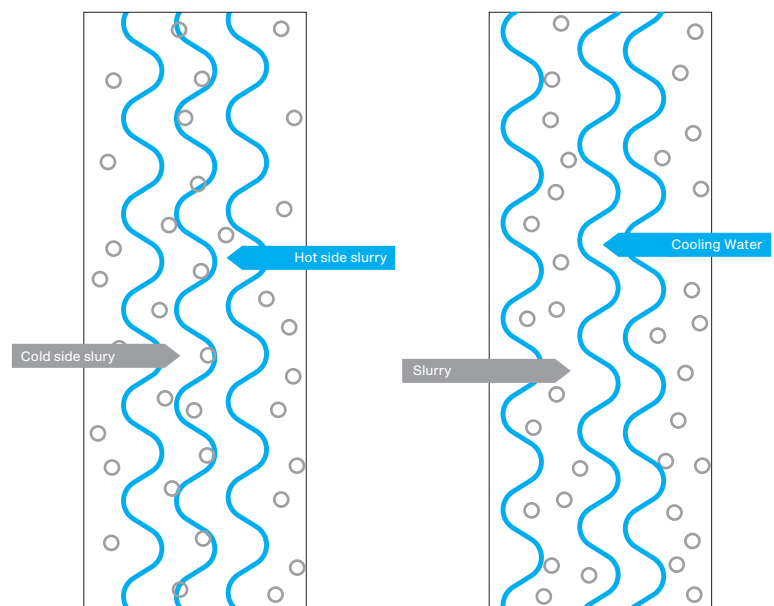
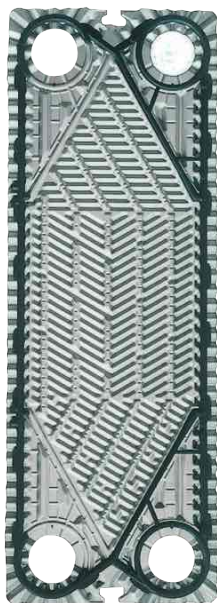

## Applications

- **Chemicals**
  - Fluids containing solids: Polyvinyl chloride (polymer), various slurry fluids
  - High viscosity fluids: Rubber latexes, resin latexes
- **Dyeing**
  - Fluids containing fibers: Waste fluid from Dyeing machine
  - High viscosity fluids: Viscose
- **Sugar**
  - Fluids containing solids: Raw juice, sugar making process such as the Steffen process, processed fluids, factory waste water
- **Pulp and paper**
  - Fluids containing fibers: Diluted black liquor, white liquor
- **Other**
  - Plating fluid containing sludge, quenching oil
  - High concentration sodium hypochlorite, sodium aluminate
  - Heat transfer for significantly different flow rates on the hot / cold sides plant
  - Snow melting plant

# Double-lined Gasket Plate HESTIA NX-50 Plate (FH-NX)

Cutting-edge technology, expanding the limits of Plate and Gasket Heat Exchangers, designed for high pressure and temperature application and maximum safety against leakage

## Double-Gasketed Line Design

The double gasketed line design provides a gasket line to the outermost periphery to inhibit oxidation degradation in the inner gasket (which serves as a seal) from outside air.

- Inhibits Oxidation Degradation
- Prevents Leakage Dispersal
- High heat-resistance and high pressure-resistance
- Two sizes available (DN 150/200)

## Applications

- High-temperature/High-pressure fluids  
High-temperature, High-pressure heat exchangers around boilers  
Heat exchangers in conventional/Nuclear power applications
- Dangerous fluids  
Heat exchangers for flammable and dangerous fluids in locations such as chemical plants and dangerous fluids

## Leak Detection Holes

It allows detection of inner gasket failure without any exterior leakage.

- Detect leaks
- Dangerous fluids suitable

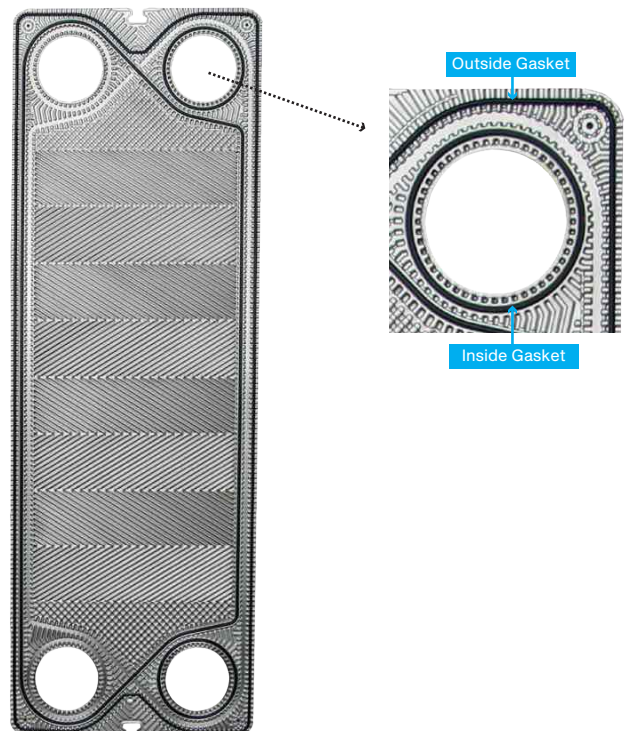

# Dual Wall Plate (FH-CW)

## The Dual Wall series for maximum safety against fluid mixing

The Dual Wall structure and Double seal gasket prevent a mix of the two fluids. In case one of the plates were to fail, the leak can be detected from outside because of leaking through the gap of the plates.

- Wide applications where possibility of mixing fluids is extremely dangerous or not permitted to avoid cross contamination between fluids
- Easily cleanable and accessible

## Applications

- Cooling of transformer oil
- Cooling of lubrication or hydraulic oil
- Heating/ cooling of fuel oil
- Heating/ cooling in bioprocess
- Heating/ cooling between fluids where mixing can cause a sudden chemical reaction or generate environmental pollutants

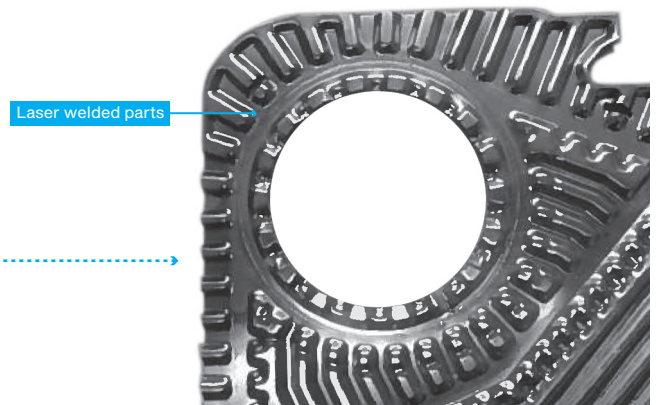
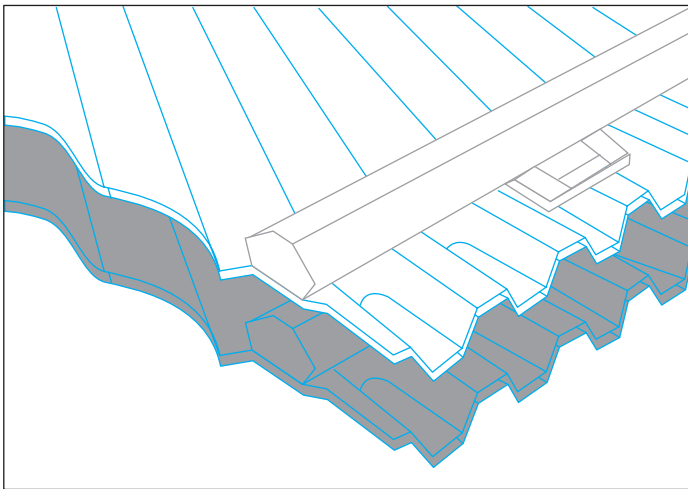

Two identical plates are stacked and laser-welded around the portholes







# Gaskets and Special Gaskets

Gaskets used in plate heat exchangers need durability to withstand a wide range of liquid qualities and temperature/pressure conditions.

Our original gaskets are manufactured under strict quality control with the highest material quality to support a wide variety of applications.

Combined with a careful gasket material selection, high performance and gasket durability is easily achieved.

Main material available is:

Material	Application	Temperature
NBR	Water, Brine, Oil application	130°C
EPDM	Steam, Hot Water, Caustic Soda, Alcohol, Ammonia, Weak acid & Alkaline solution	150°C
EPDM-HT	Steam, Hot Water, Caustic Soda, Alcohol, Ammonia, Weak acid & Alkaline solution	180°C
PTFE Encapsulated NBR/EPDM	Organic Chemicals, Solvent, Ultra-Pure water, High chemical resistance	150°C
FKM (VITON)	Good chemical resistance towards concentrated acids, Oils, Lubricants and Fuels	175°C
N-EPDM	High temperature, Aggressive media, Improved sealing performance from EPDM	180°C

## Slit-In Gasket (Glue-free type)

Most of our gaskets are of Slit-In type, an easy-to-use and glue-free system.

Attached with a fitting structure that does not use glue.

- Reduction of glue odour
- Shorter maintenance work
- Suitable for applications where frequent replacement of the gasket is required

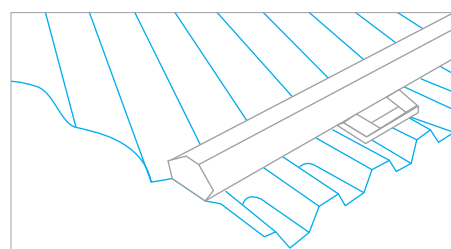
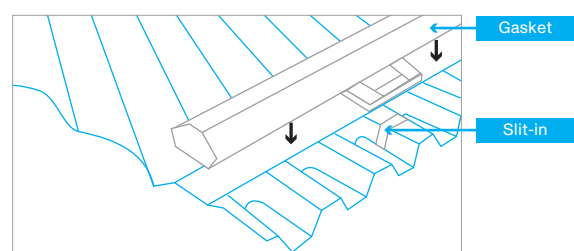

## NEW-EPDM (N-EPDM)

### New EPDM with High-performance and superior resistance to heat & chemicals

New gasket material developed to expand the gasket lifetime, contributing to lower the total cost of ownership and minimize downtime times by minimizing gasket replacement.

The newly developed EPDM gasket that has heat resistance and chemical resistance far superior to conventional EPDM, making gasket lifetime to be up to two times higher than regular EPDM and contributes to the best energy saving.

- Excellent sealing performance
- Higher heat resistance and amine resistance



### Suitable for:

- Applications caustic soda concentrating equipment in high-temperature regions
- In high-temperature regions where long service life is desired
- Hot water applications (drains, sterile water, etc.) with 51x enhanced resistance to heat and chemicals

Lifetime of New-EPDM and EPDM (180°C)

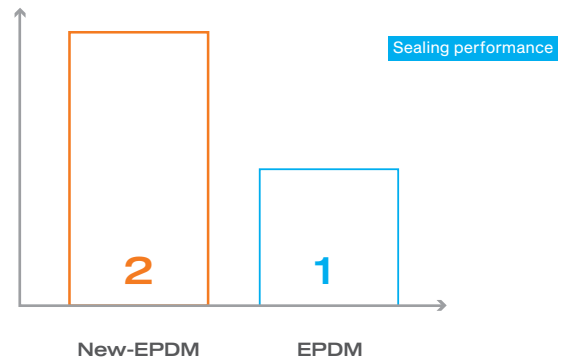

## PTFE Cushion Gaskets (TCG)

The TCG gasket is integrally molded by wrapping elastic synthetic rubber with a fluorinated resin film, featuring excellent chemical resistance and low friction.

- High chemical and solvent resistance
- Stable and high sealing performance
- Measures to eliminate odours from “rubber odour” and fluids
- Optimisation of gasket material and cost reduction
- Ease of maintenance is improved by adopting the Slit-In method
- Compatible with pressure vessel structure standards

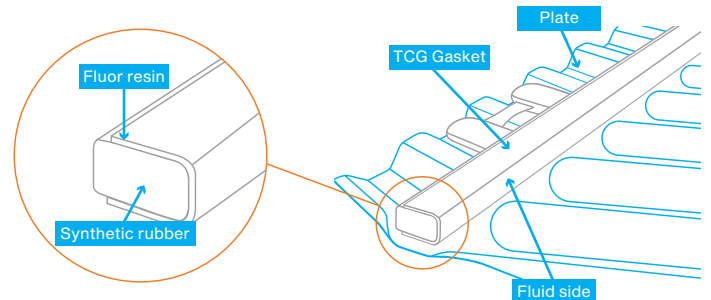

### Suitable for:

- Applications with limited use of synthetic rubber such as fine chemicals, petrochemicals and pharmaceuticals

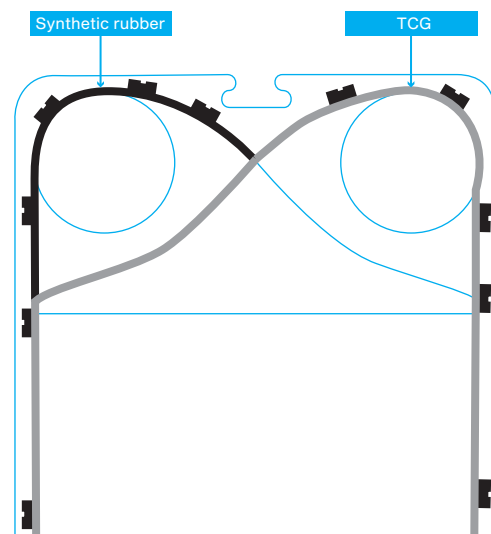
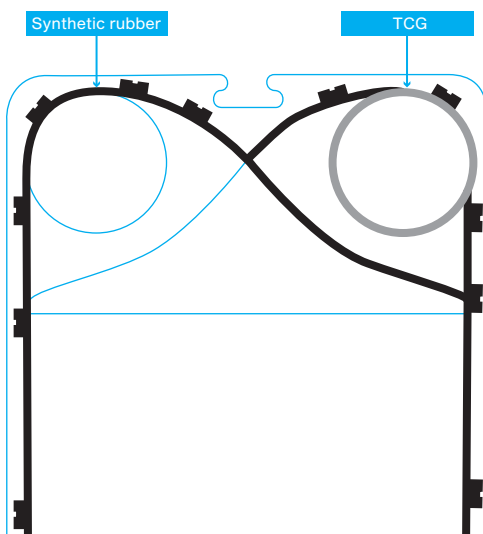







# Examples of Applications for Chemical Industry

## Reactor I

### Jacket cooling water indirect cooler

During an operation involving exothermic chemical reaction, industrial cooling water is necessary to remove heat from the reaction. Such industrial water is usually dirty and includes fibers, particles and other foreign matter. An indirect cooling method (by way of inserting PHE between industrial water and cooling water), it is effective in minimizing choking, fouling, corrosion or other problems in the reactor.

Typical application: Polyolefin, PVC

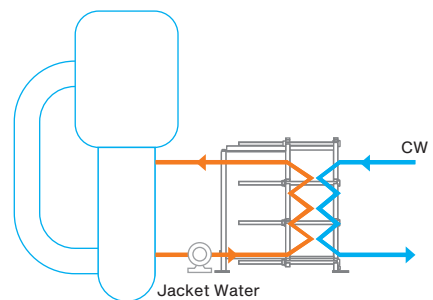
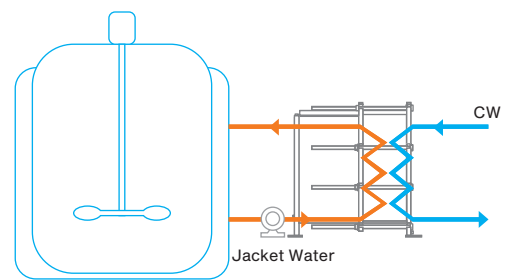

## Reactor II

### Pre-heater/Product cooler & Inter changer/ Vent Condenser

PHEs are also applicable to different endothermic chemical reaction, from heating process feed, cooling the product, to heat recovery from feed to product. PHE condensers are also applicable as a vent condenser.

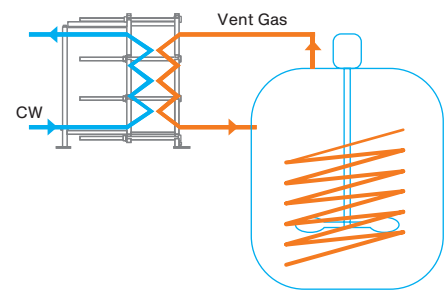
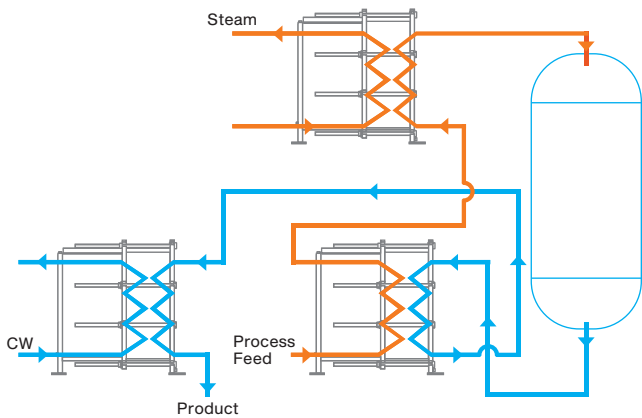

## Gas Treatment II

### Absorber and Stripper

When one component is needed to remove from the gas, the gas goes to the absorber, where the circulating solvent selectively absorbs the undesirable component in the gas. PHEs can apply to the lean and rich solvents leaving the stripper and absorber respectively.

Typical application:  
Desulfurization, CO<sub>2</sub> Recovery.

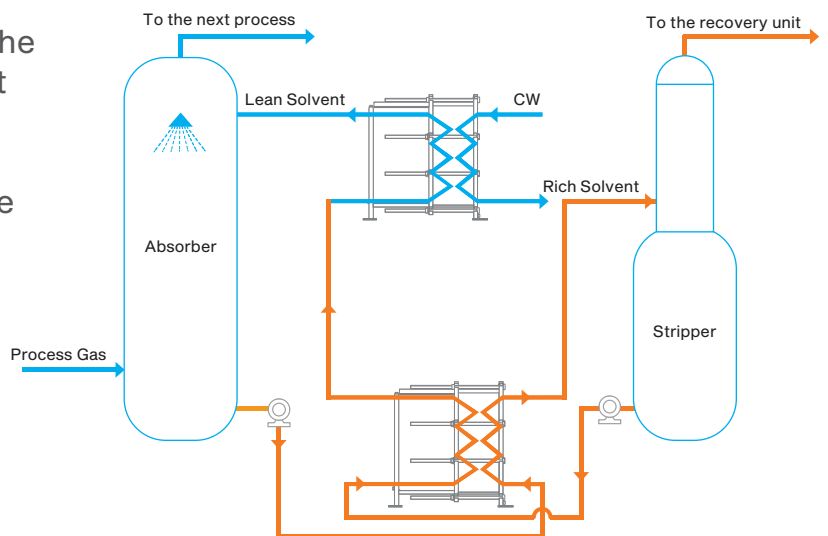

# REQUEST A QUOTATION

For a quotation for a Plate Heat Exchanger, please inform us the followings:

1. Heat Duty	kW	
	Hot stream	Cold stream
2. Fluid name		
3. Inlet Temperature (°C)		
4. Outlet Temperature (°C)		
5. Flow rate (m <sup>3</sup> /h)		
6. Pressure loss (MPaG)		
7. Max working pressure (MPaG)		
8. Special notes: Plate/Gasket materials, thickness, etc.		
9. Batch (if batch process) Volume/Time		

## Portugal

### Head Office

Rua Senhora da Graça 1212  
3730-541 Vale de Cambra Portugal  
+351 256 410 410  
[thermal@arsopi-thermal.pt](mailto:thermal@arsopi-thermal.pt)

**Industry/Chemical Business Unit**  
[industry@arsopi-thermal.pt](mailto:industry@arsopi-thermal.pt)

### Technical Assistance & After-Sales Services

+351 256 410 413  
[aftersales@arsopi-thermal.pt](mailto:aftersales@arsopi-thermal.pt)

## Spain

### Delegation Basque Country

+34 605 581 548  
[basque-country@arsopi-thermal.pt](mailto:basque-country@arsopi-thermal.pt)

### Delegation Catalonia

+34 605 891 672  
[catalonia@arsopi-thermal.pt](mailto:catalonia@arsopi-thermal.pt)

## France

### Delegation Auvergne-Rhône-Alpes

[auvergne-rhone-alpes@arsopi-thermal.pt](mailto:auvergne-rhone-alpes@arsopi-thermal.pt)

